

Chapter 5: Stereoisomerism

[Sections: 5.1-5.9]

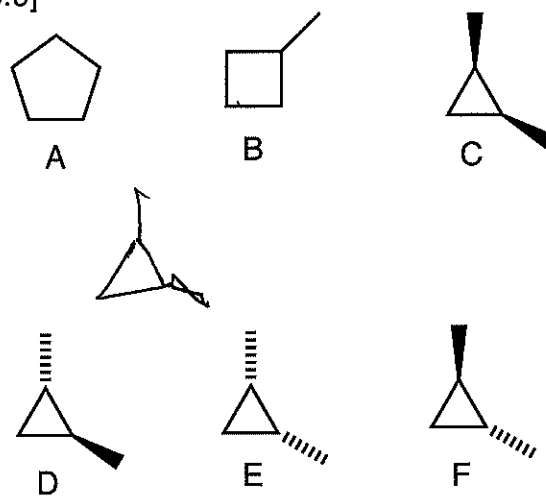
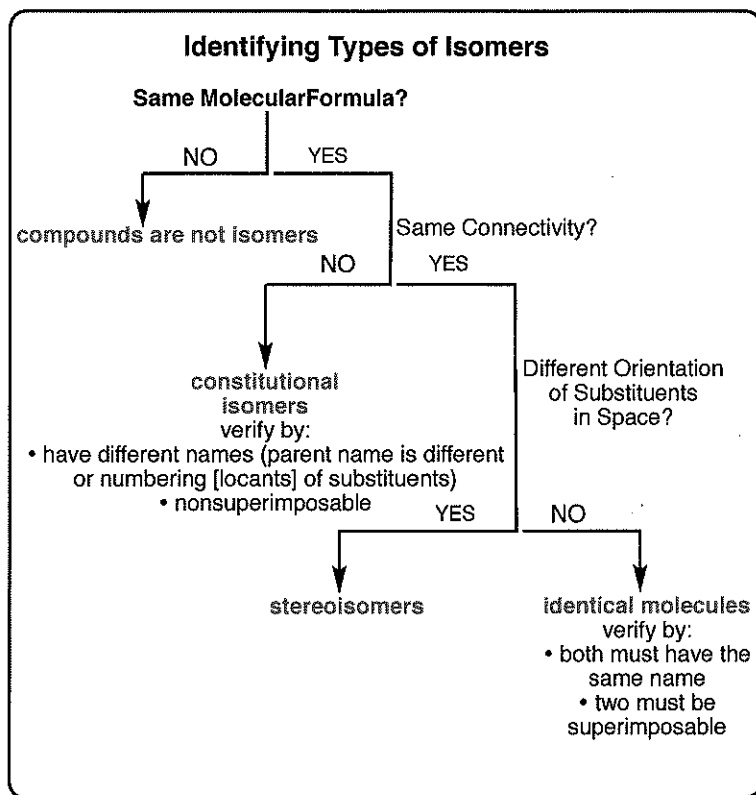

A and B? CONSTITUTIONAL
 A and C? CON ST.
 C and D? STEREO
 D and E? STEREO
 C and E? IDENTICAL
 D and F?

Defining Chirality



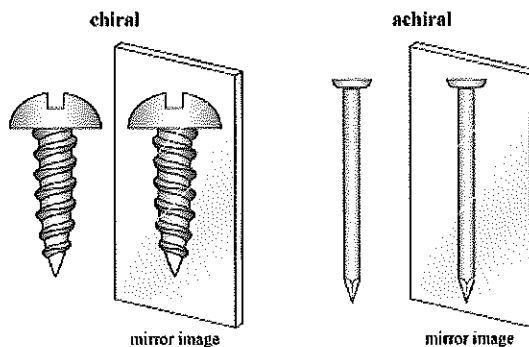
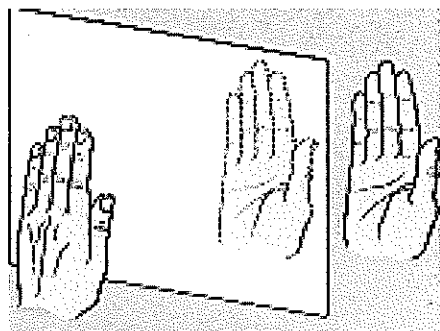

- a chiral object is any object with a non-superimposable mirror image
- the mirror image of a chiral object is **not** identical (i.e., not superimposable)
- an achiral object is any object with a superimposable mirror image
- the mirror image of an achiral object is identical (i.e., superimposable)

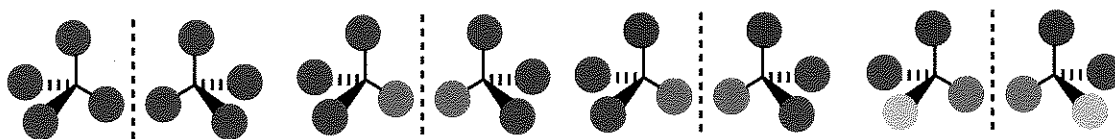

different types
of groups and/or
atoms the central
atom is attached to:

mirror image
superimposable?

chiral?

1
Y
ACHIRAL

2
Y
ACHIRAL

3
Y
ACHIRAL

4
NO!
CHIRAL!

- molecules can also be chiral
- the mirror image of a chiral molecule is non-superimposable and is therefore an isomer
- since the two mirror image compounds have the same connectivity, they are **NOT** constitutional isomers
- the two mirror image compounds are nonsuperimposable due to different orientations of substituents in space: **stereoisomers**
- non-superimposable stereoisomers that bear a mirror-image relationship are **enantiomers**
- stereoisomers that do **NOT** bear a mirror-image relationship are **diastereomers**

stereoisomers

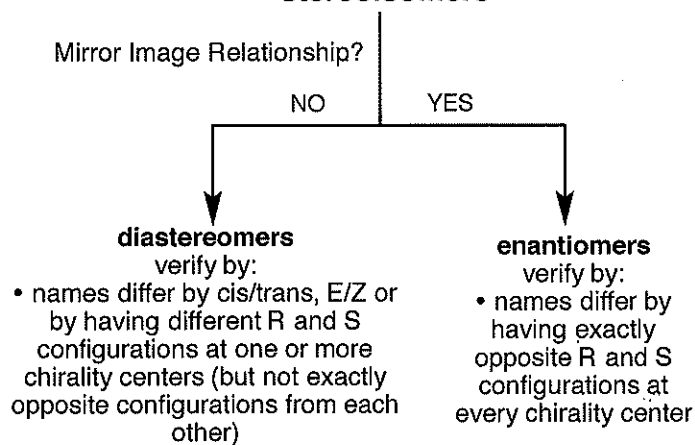

Predicting Chirality

- a molecule is potentially chiral if it contains one or more carbons attached to four different atoms or groups
- the atom (usually carbon) attached to four different atoms or groups is referred to as a chirality center or a stereogenic center
- if the molecule contains only one stereogenic atom it **will always** be chiral
- if the molecule contains more than one stereogenic atom it **may or may not** be chiral
- a chiral object or molecule will **not** have a plane of symmetry
- an achiral object or molecule **will** have a plane of symmetry

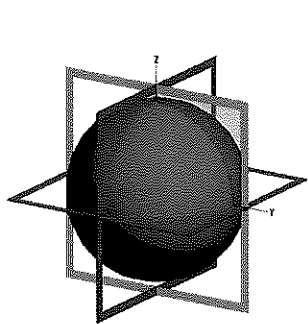

a simple ball has an infinite number of planes of symmetry

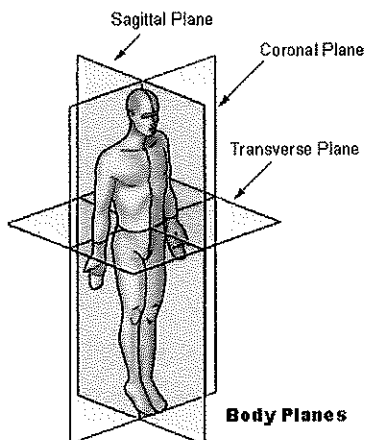

accupuncture symmetry planes

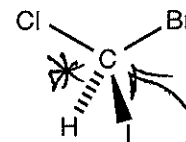
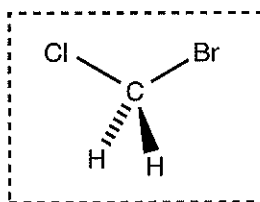
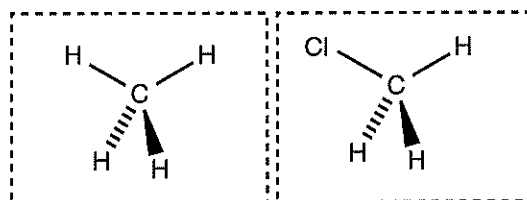

STEREogenic CARBON

examples

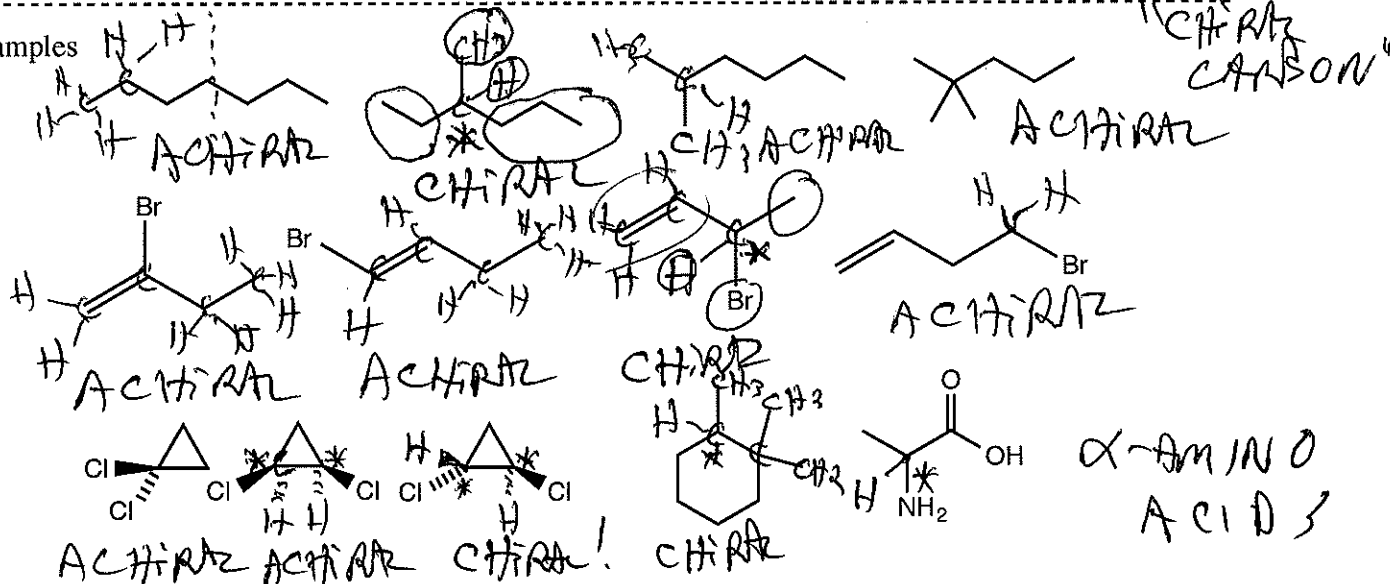

drawing the enantiomer (i.e., the mirror image isomer)

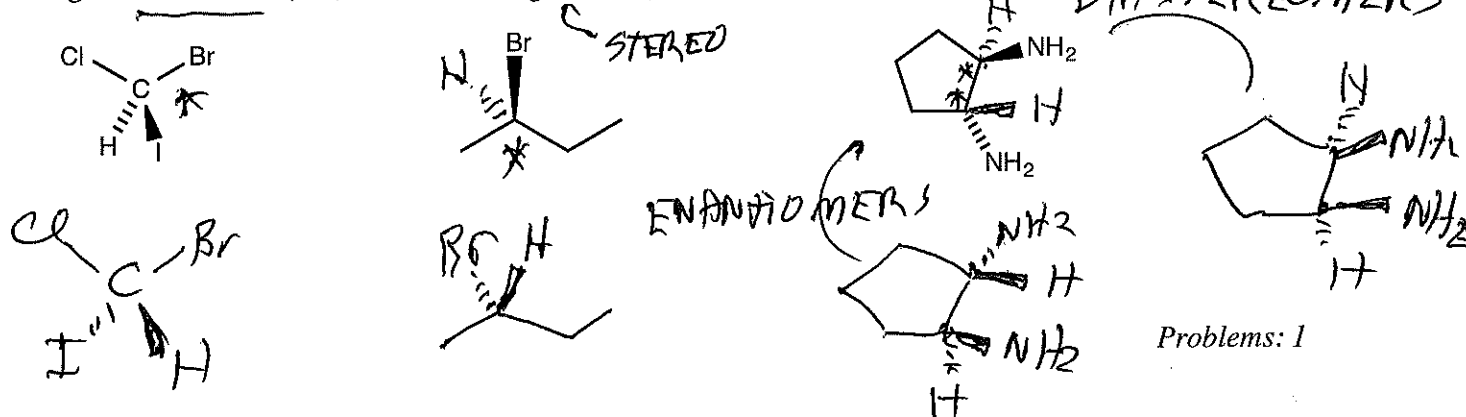

Problems: 1

Detection of Chirality with a Polarimeter

- Light emanating from a source is emitted as waves in random planes (see **A**).
- However, light is "polarized" when it is passed through a polarizing lens such that light oscillating in a single plane is allowed to pass (i.e. plane polarized light)
- The plane of polarized light may be passed through a solution of a compound.
- A second polarizing lens indicates whether the plane in which the light is oscillating is affected by the solution (see **B**).
- A solution of achiral molecules does not affect the light. Such a solution is said to be "optically inactive"
- A solution containing a chiral compound (more specifically, a single enantiomer) will rotate the light through a small angle (see **C**).
- The light may be rotated to the right or dextrorotatory, i.e. (+). The light may be rotated to the left or levorotatory, i.e. (-) (see **D**).
- A solution of a compound that rotates a plane of polarized light is said to be "optically active".
- The rotation of light is cumulative, i.e., the more molecules of chiral compound present, the greater the rotation. Therefore, the "observed" angle of rotation is dependent upon:

1. The concentration of the solution
2. The length of the tube
3. The wavelength of light used
4. The temperature of the solution

- If these factors are taken into account using the equation below, the "**specific rotation**" of a compound is a **property** of that compound:

$$\alpha \quad [a]_D^{20^\circ} = \frac{\text{observed rotation}}{\text{path length} \times \text{concentration}}$$

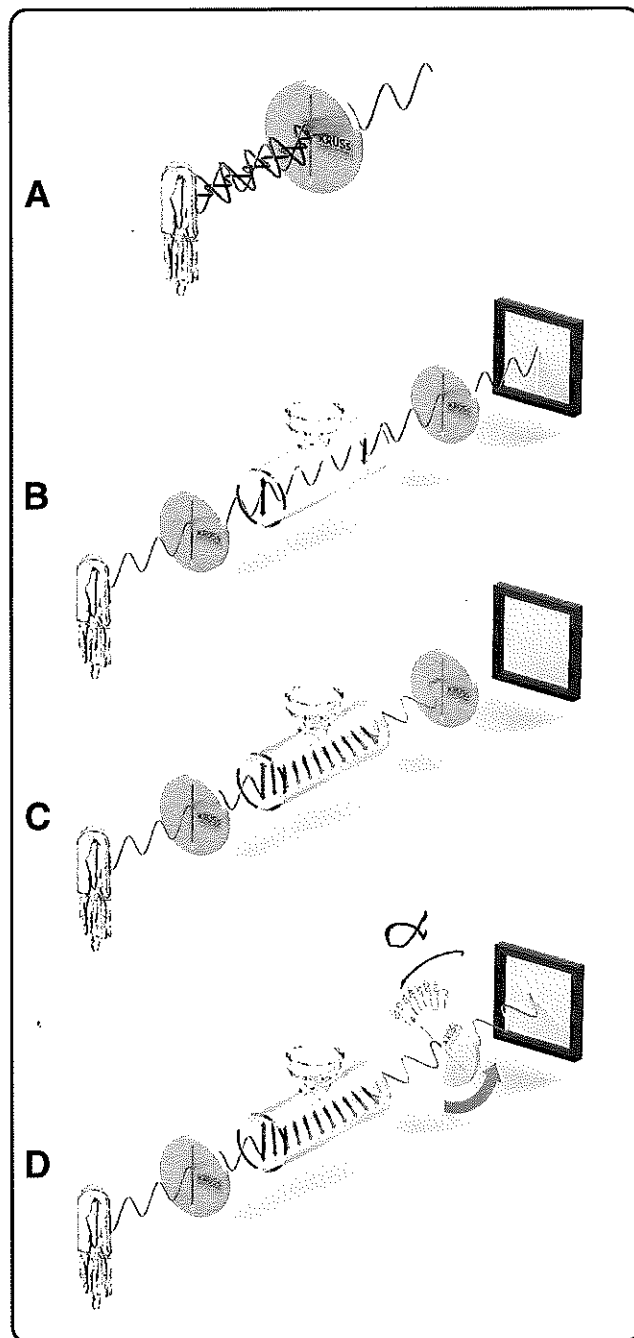

Example

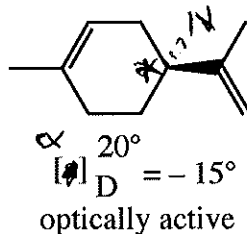
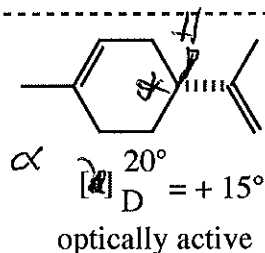

50/50 mixture of the two:

observed rotation = 0° (CANCEL EACH OTHER)
optically active? **OPTICALLY INACTIVE**
name of mixture: **RACEMIC MIXTURE**

Nomenclature of Chiral Compounds

- locate the chirality (stereogenic) center(s)
- for each stereogenic center, rank the substituents according to the Cahn-Ingold-Prelog rules:
 - i. starting at the chirality center of interest, view each atom directly connected to it and rank the atoms according to their atomic number
 - ii. higher atomic numbers are assigned higher priorities
 - iii. if the atomic numbers are identical, move out one atom at a time until the first point of difference allows for assigning a higher priority
- ensure that the lowest priority (i.e., ranked) atom or group is positioned "away" from the observer
- if the remaining three substituents (i.e., IGNORE the lowest priority group) are oriented in a "clockwise" pattern, the stereochemistry is designated as R
- if the remaining three substituents are oriented in a "counterclockwise" pattern, the stereochemistry is designated as S

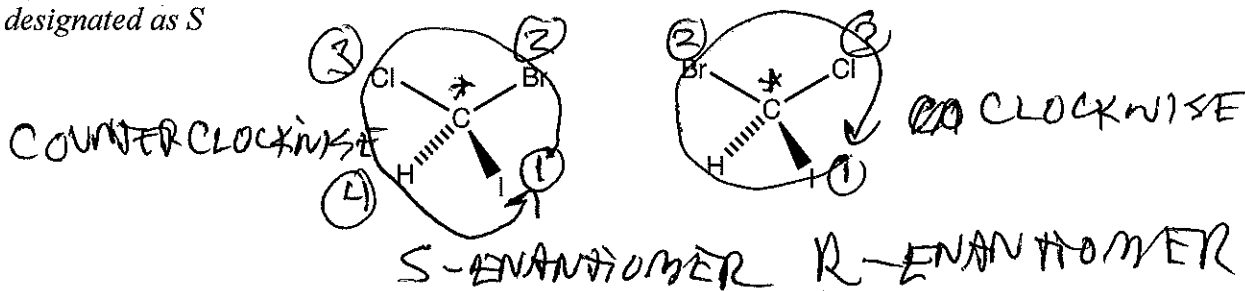

- determining the R vs S of stereogenic carbons is considered to be determining the "configuration" of the stereogenic center
- for a pair of enantiomers, the configuration will be inverted at EVERY stereogenic carbon in the molecule (i.e., if one is R, that same carbon will be S in the enantiomer)

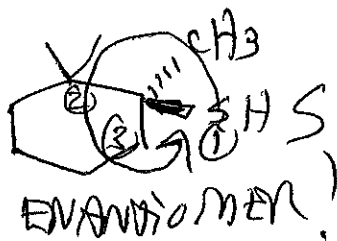
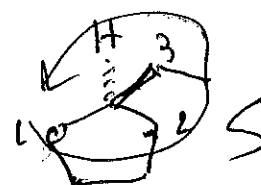
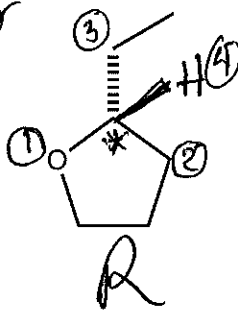
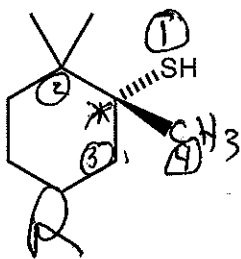
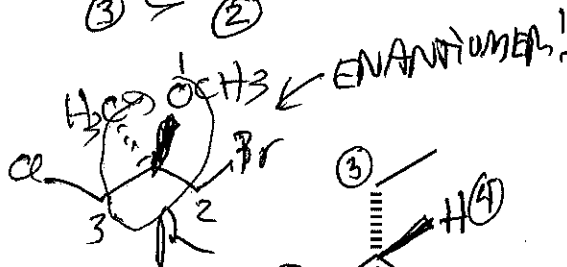
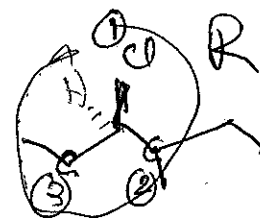
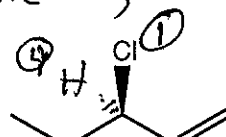
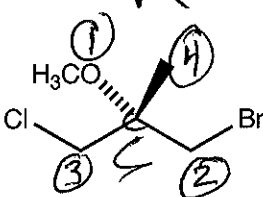
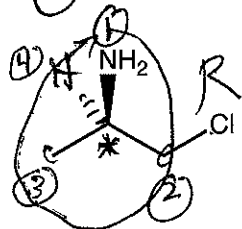
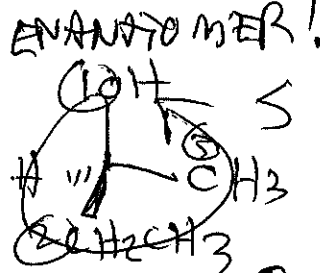
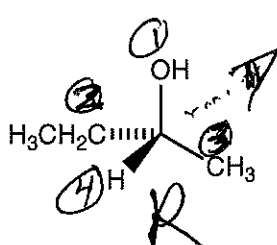
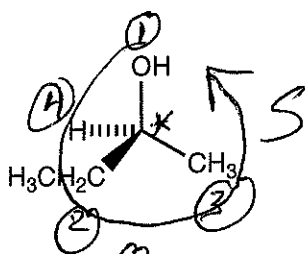

ENANTIOMER!

Why Is Chirality Important in Medicines?

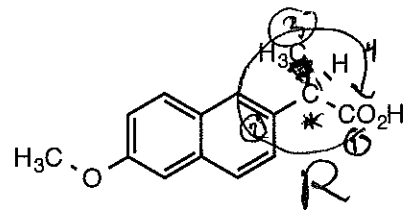
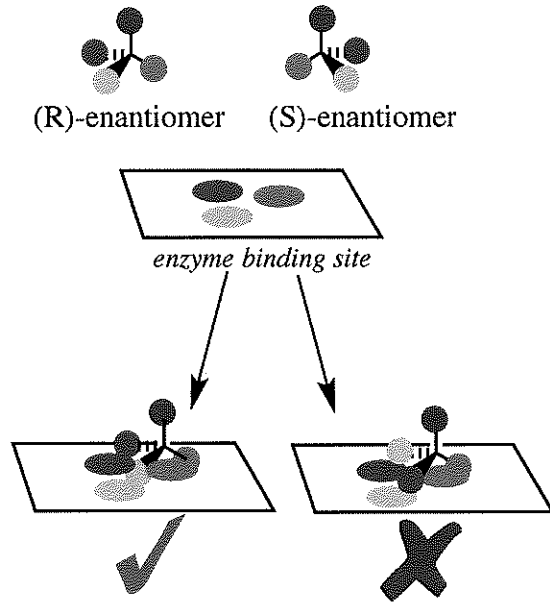

(S)-enantiomer is used as Naproxen (Aleve)
 (R)-enantiomer is a liver toxin

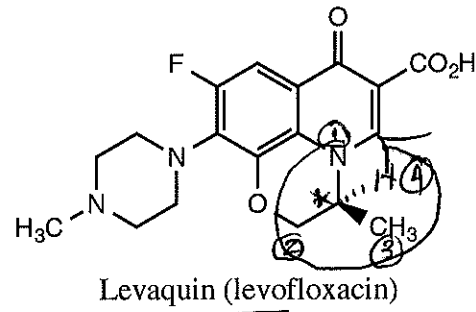

R or S? **S**
 + or -? **-**
 absolute configuration? **(-)-S-LEVAQUIN**

• the "absolute configuration" for a molecule is when the experimental direction of optical rotation is matched with the stereochemical configuration

Example: Thalidomide

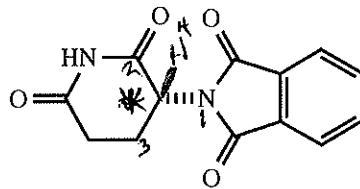

(+)-R-LEVAQUIN = ENANTIOMER

Thalidomide, first synthesized in 1953, was widely prescribed for morning sickness from 1957 to 1962, but only outside of the U.S. In 1961 the U.S. Food & Drug Administration was glad it had not given approval, because thalidomide became anathema when it was found to be seriously teratogenic (creating malformation in embryos, from the Greek for "monster") having caused serious birth defects in more than 10,000 babies. Now, a quarter of a century later, it appears that it may be a miracle drug for such diseases as AIDS, leprosy, lupus, and tuberculosis. Within the last year, and over the objection of groups focussed on the risk and seriousness of birth defects, the F.D.A. has approved its use with strict safeguards to protect women who are, or could become pregnant.

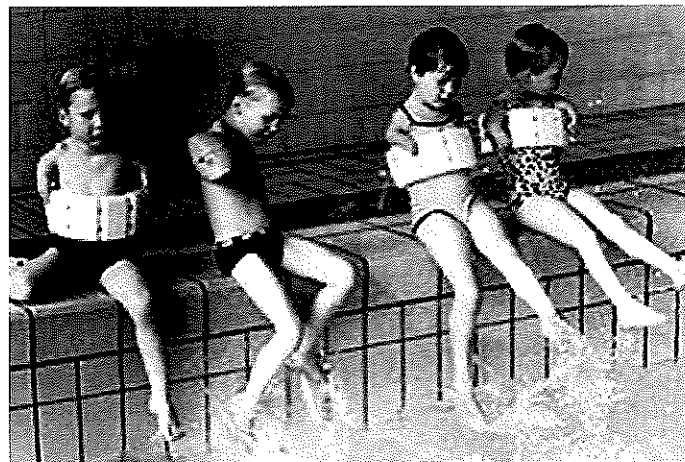

Molecules With More Than One Chirality Center

consider

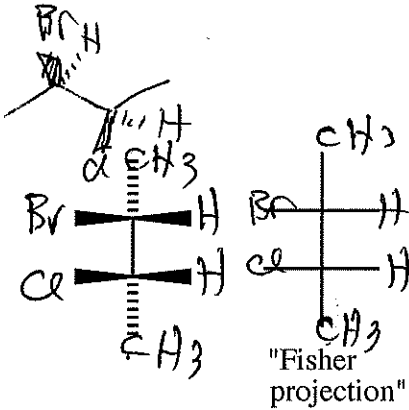
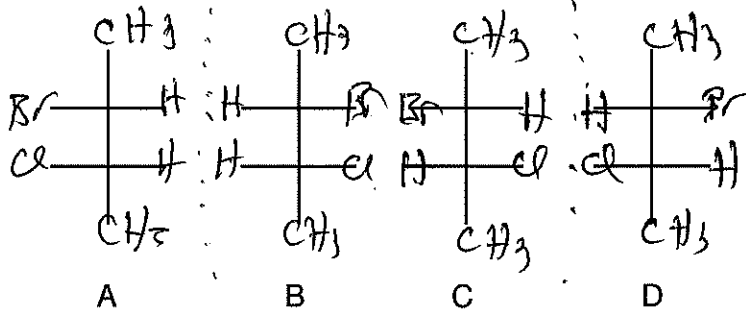
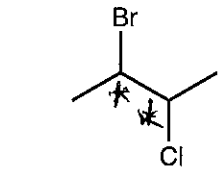

$$2^n = 2^2 = 4$$

Relationship?

- A, B = ENANTIOMERS
- A, C = DIASTEROMERS
- C, D = ENANTIOMERS

• total number of possible stereoisomers = 2^n where n = number of chirality centers

name

- they are all 2-bromo-3-chlorobutane

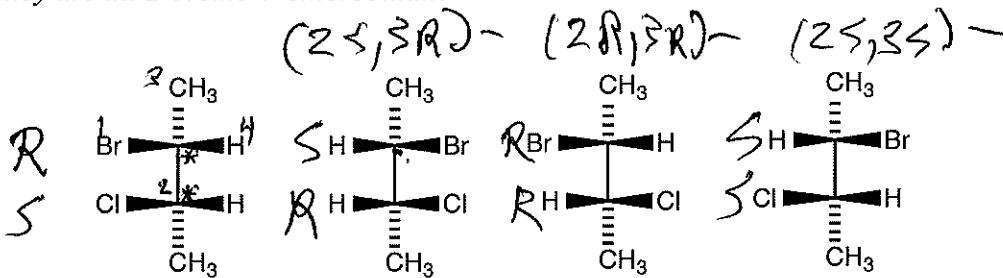

$(2R, 3S)$ -2-BROMO-3-CHLOROBUTANE

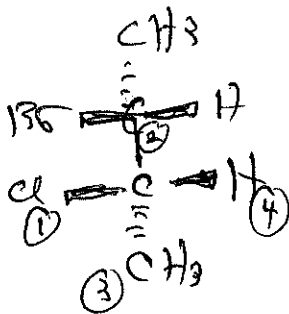
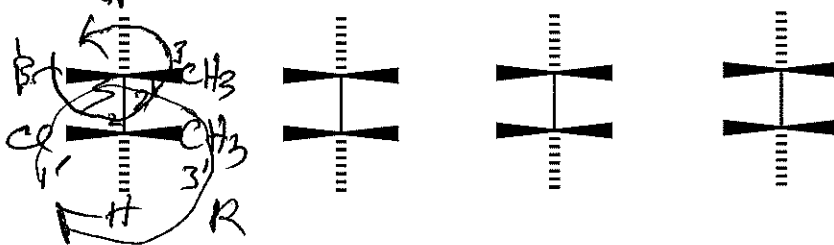

consider

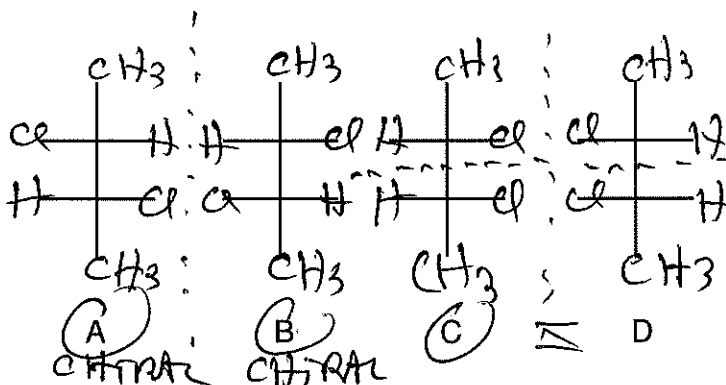
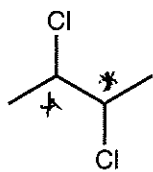

Relationship?

A,B = ENANTIOMERS
 A,C = DIASTEREOMERS
 C,D = IDENTICAL

$2^2 = 4$

CHIRAL

- a compound with chirality centers, but is achiral because of the presence of a plane of symmetry = **meso compound**
- meso compounds are achiral and therefore optically inactive

Problems: 2-5, 7-10

Physical Properties of Enantiomers and Diastereomers

- enantiomers have identical physical properties (spectra, melting point, boiling point, density, etc.)
- diastereomers generally have similar but different physical properties

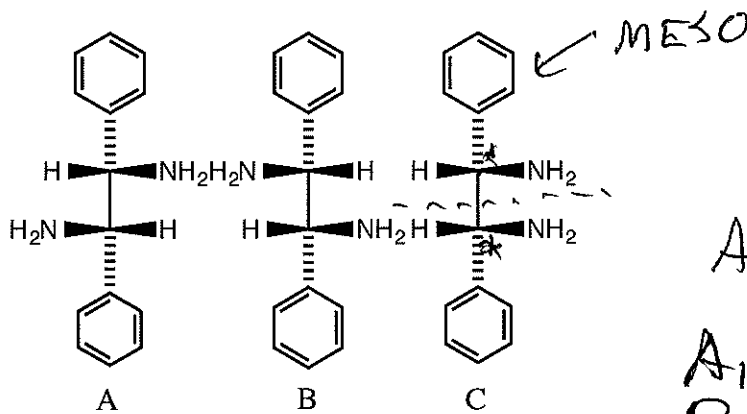

m.p.	84 °C	84 °C	120 °C
TLC R _f	0.6	0.6	0.8
[α] ₂₀	+102°	-102°	0°

LEVOROTATORY

DEXTROROTATORY

A: (+)-(1S,2S)-1,2-diamino-1,2-diphenylethane

B: (-)-(1R,2R)-1,2-diamino-1,2-diphenylethane

C: (X)-(1S,2R)-1,2-diamino-1,2-diphenylethane

(1S,2R)-

A, B = ENANTIOMERS

A, C > DIASTEREOMERS
 B, C > DIASTEREOMERS

ENANTIOMER,
 DIASTEREOMERS

Problems: 6